

COMPACT

Cylinders ISO 21287



Find out our
key products



Solution for most applications



Easy and intuitive choice



Excellent value for money



Wide availability



Fast delivery



Features and certifications

Series of compact cylinders conforming to ISO 21287 standards. The barrel with grooves allows the mounting of magnetic reed switches directly in the tube without brackets. Available in bores from Ø 16 to 125, single acting or double acting, magnetic, with elastic dampers on the piston. These cylinders are compatible with ISO 15552 mounting accessories. Supplied as standard in compliance with Reach and RoHS directives, and SIL certificated. On request, they can be also supplied according to the 2014/34/EU ATEX Directive.



Type CIS Ø 16 ÷ 100

from page 1.16.20



Compact cylinders conforming to ISO 21287, available in bores from Ø 16 to 100, single acting, magnetic, with elastic dampers on piston. Barrel with grooves allows mounting of magnetic reed switches directly, not protruding beyond the profile of the cylinder.

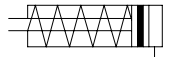









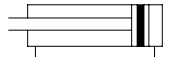

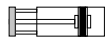
Type CI Ø 16 ÷ 125

from page 1.16.20

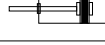

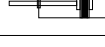
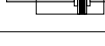
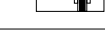
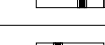
Compact cylinders conforming to ISO 21287, available in bores from Ø 16 to 125, double acting, magnetic, with elastic dampers on piston. Barrel with grooves allows mounting of magnetic reed switches directly, not protruding beyond the profile of the cylinder.

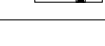
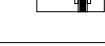

Options		
Description	Symbol	Suffix
Anti-rotating plate (available only for CI type, up to Ø 100)		N
Rear spring (available only for CIS type)		T
Male threaded rod		M
Through rod		P
FKM seals	-20°C ÷ +150°C 	V
FKM rod seal	-20°C ÷ +80°C 	V1
Low temperature seals	-40°C ÷ +80°C 	BT
Tandem forward movement piston rods coupled together (available only for Ø 20, Ø 40 and Ø 63)		TA1
Tandem forward movement piston rods independent (available only for Ø 20, Ø 40 and Ø 63)		TA2
Tandem back to back (available from Ø 20)		TA3
Tandem front to front (available from Ø 20 up to Ø 100)		TA4
Extended rod (indicate the requested WH dimension in mm, E.g.: WH=100; for further information please contact the sales department)		WH=..
Special thread (indicate the requested thread. E.g.: R-M 10x1,5; if combined with option M, the AM dimension of the special thread will be the same as the standard; the cylinder will be supplied without rod nut; for further information please contact the sales department).		R-M..
ATEX versions on request		/ATEX
Special versions on request		/S

The options, when this is possible, can be combined with each other. For options matching see from page 1.16.4; For code key see from page 1.16.6

Options matching

Series	Bore	Model	Standard options matching				
			N (Ø16÷100)	T	M	P	V
CIS	Ø 16 ÷ 100	Standard	-	●	●	-	●
		Rear spring (T)	-		●	-	●
		Male threaded rod (M)	-	●		-	●
CI	Ø 16 ÷ 125	Standard	●	-	●	●	●
	Ø 16 ÷ 100	Anti-rotating plate (N)		-	● ⁽³⁾	●	●
	Ø 16 ÷ 125	Male threaded rod (M)	● ⁽³⁾	-		● ⁽³⁾	●
		Through rod (P)	●	-	● ⁽³⁾		●

Key

● allowed matching; - not allowed matching

Options matching - notes

(1) Option **WH=.** require to indicate the desired dimension (in mm). For further information please contact the sales department.

(2) Option **R-M.** require to indicate the desired thread. For further information please contact the sales department. if combined with male threaded rod (option **M**) the cylinder will be supplied without rod nut.

(3) The male threaded rod (option **M**) in combination with through rod (option **P**) is applied on both sides of rod, except when combined with the anti-rotation plate (option **N**), in which case the male rod will only be applied on the side opposite the plate.

Standard options matching

V1	BT	TA1 (Ø20-40-63)	TA2 (Ø20-40-63)	TA3 (Ø20-125)	TA4 (Ø20-100)	WH=.. ⁽¹⁾	R-M.. ⁽²⁾	/ATEX
•	•	-	-	-	-	•	•	•
•	•	-	-	-	-	•	•	•
•	•	-	-	-	-	•	•	•
•	•	•	•	•	•	•	•	•
•	•	•	•	•	-	•	•	•
•	•	•	•	•	-	•	•	•
•	•	-	-	-	-	•	•	•

Code key

Bore	/	Stroke	Type	Options		
40	/	80	CI			M

Ø 16, 20, 25, 32, 40, 50, 63, 80, 100, 125	See table on page 1.16.20	CIS Single acting Magnetic CI Double acting Magnetic	N	T	M
---	---------------------------	---	---	---	---

Standard materials

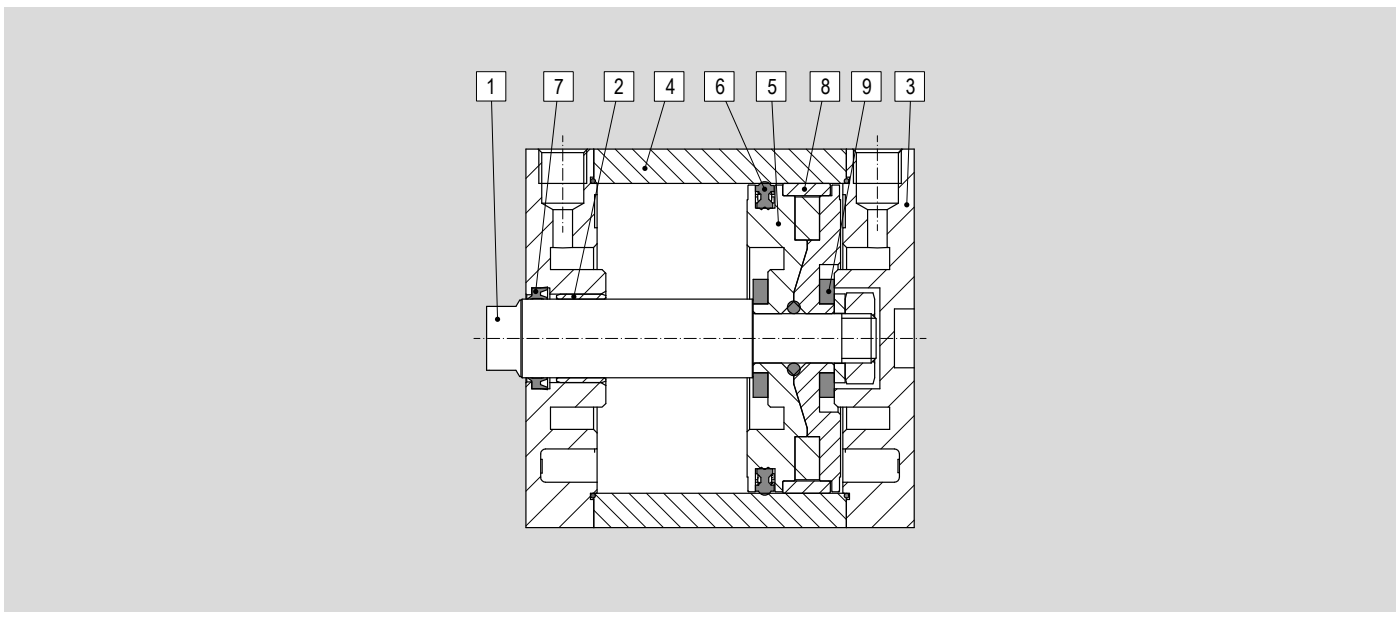

Position	Description	Materials			
		Ø 16	Ø 20 ÷ 25	Ø 32 ÷ 100	Ø 125
1	Rod	Stainless Steel AISI 304			
2	Bushing	Stainless Steel	Sintered bronze	PTFE	
3	Heads	Die-cast painted aluminium			Anodised aluminium
4	Tube	Anodised aluminium			
5	Piston	Polyurethane (PU)	POM-C / Aluminium	Aluminium	
6	Piston seal	NBR			
7	Rod seal	Polyurethane (PU)			
8	Guide ring	Steel / PTFE			
9	Elastic dampers	NBR			
-	Other seals	NBR / Polyurethane (PU)			

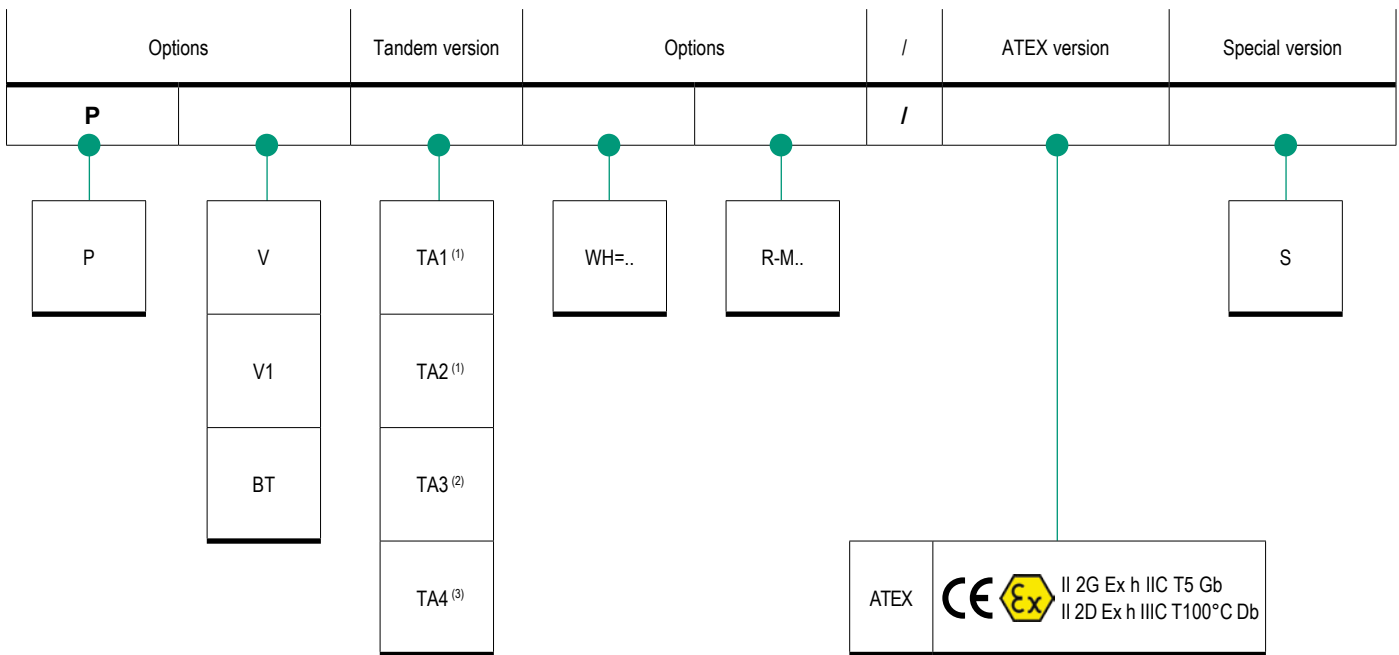

How to order **Notes**

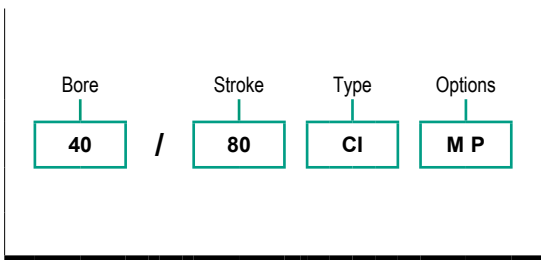

Options in the same grid are alternative to each others.
 For further information on options and their matching, see page 1.16.3 and page 1.16.4
 For further information on the ATEX 2014/34/EU Directive, on classifications and protections, see from page III.1
 (1) Available only for Ø 20, Ø 40 and Ø 63
 (2) Available from Ø 20
 (3) Available from Ø 20 to Ø 100

Standard* seal kit

Number of components	Description
n. 1	Rod seal
n. 2	Tube-head o-ring
n. 1	Piston seal
n. 2	Elastic dampers

*For cylinders with option P the kit include further components.

Standard seal kit code key

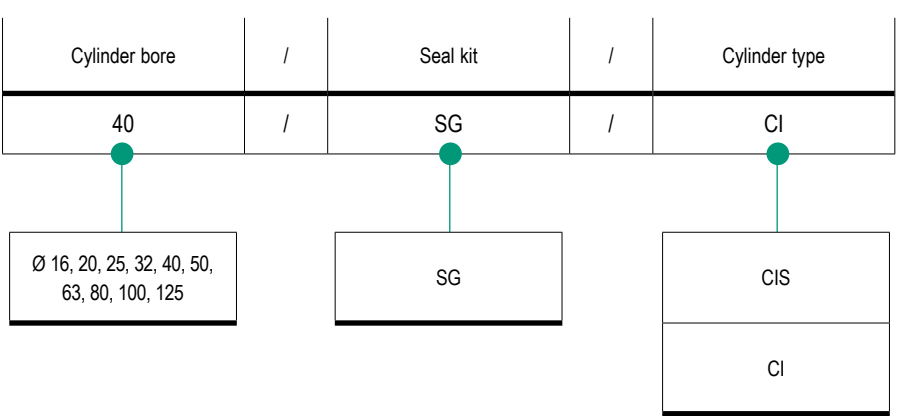

Accessories

1 - CYLINDERS

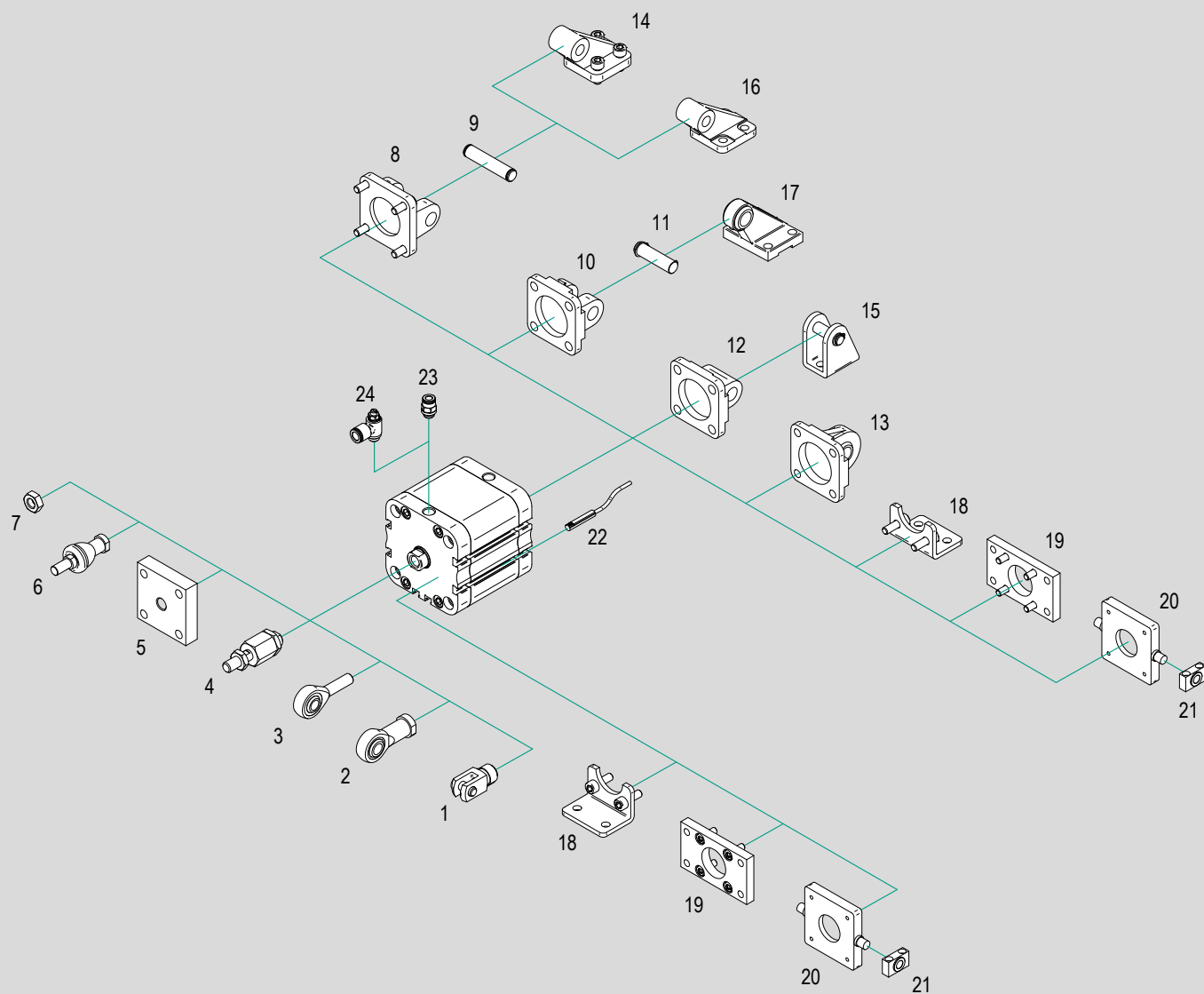

N.	Cylinder bore	Item	Description	Compliance	Matching		Code page	Data sheet page
					CIS	CI		
1	∅ 16 ÷ 125	FF..ISO	ISO female clevis with clip	ISO 8140	● ⁽¹⁾	● ⁽¹⁾	1.16.90	1.85.10
	∅ 20 ÷ 125	FFP..ISO	ISO female clevis with pin and seeger		● ⁽¹⁾	● ⁽¹⁾		1.85.11
		FFN..ISO	ISO female clevis (body only)		● ⁽¹⁾	● ⁽¹⁾		
2	∅ 16 ÷ 125	RF..SE	Bearing head (DIN 648K) with female thread	ISO 8139	● ⁽¹⁾	● ⁽¹⁾	1.90.1	
3	∅ 16 ÷ 125	RM..SE	Bearing head (DIN 648K) with male thread		●	●	1.90.2	
4	∅ 16 ÷ 125	GB..	Bearing - Self-aligning articulated coupling		● ⁽¹⁾	● ⁽¹⁾	1.90.10	
5	∅ 16 ÷ 125	GC..	Self-aligning coupling	-	● ⁽¹⁾	● ⁽¹⁾	1.90.40	
6	∅ 16 ÷ 125	RBI..	Bearing - Axial articulated coupling	-	● ⁽¹⁾	● ⁽¹⁾	1.90.20	
		RBL..	Bearing - Angular articulated coupling	-	● ⁽¹⁾	● ⁽¹⁾	1.90.30	
7	∅ 16 ÷ 125	D..	Rod nut	UNI 5589	● ⁽¹⁾	● ⁽¹⁾	1.90.70	
8	∅ 32 ÷ 125	CF..ALIS	Rear clevis	ISO MP2	●	●	1.16.91	1.100.1
		CF..AQIS			●	●		1.100.50
9		SEC..AQIS	Pin for rear clevis	ISO AA4	●	●	1.16.92	1.100.56
10	∅ 32 ÷ 125	CFS..ALIS	Narrow rear clevis	ISO AB6	●	●	1.16.91	1.100.2
		CFS..AQIS			●	●		1.100.50
11		SEC..ARAQIS	Anti-rotating pin for narrow rear clevis	ISO AA6	●	●	1.16.92	1.100.56
12	∅ 16 ÷ 25	CM..ALUN	Rear eye	UNITOP	●	●	1.16.91	1.100.3
	∅ 32 ÷ 125	CM..ALIS		ISO MP4				
	∅ 20 ÷ 25	CM..AQUN		UNITOP				
	∅ 32 ÷ 125	CM..AQIS		ISO MP4				
13	∅ 32 ÷ 125	CMS..ALIS	Narrow rear eye with bearing (DIN 648K)	ISO MP6	●	●	1.16.91	1.100.4
		CMS..AQIS			●	●		1.100.52
14	∅ 32 ÷ 125	ASV..ALIS	Rear 90° hinge	ISO AB7 CETOP RP 107P	●	●	1.16.93	1.100.4
		ASV..AQIS			●	●		1.100.53
15	∅ 16 ÷ 25	CF..+P		ISO MP3	●	●		1.100.6
16	∅ 32 ÷ 125	AS..ALIS		ISO 6431	●	●		1.100.6
17	∅ 32 ÷ 125	ASS..AQIS	Rear 90° hinge with bearing (DIN 648K)	ISO CS7	●	●		1.100.52
18	∅ 16 ÷ 25	PB..AQUN	Low foot	UNITOP	●	●	1.16.92	1.100.55
	∅ 32 ÷ 125	PB..AQIS		ISO MS1	●	●		
19	∅ 16 ÷ 25	FL..ALUN	Flange	UNITOP	●	●	1.16.92	1.100.5
		FL..AQUN			●	●		1.100.54
	∅ 32 ÷ 125	FLV..ALIS		ISO VDMA MP1/MP2	●	●		1.100.5
		FLV..AQIS		●	●	1.100.54		
20	∅ 32 ÷ 125	CTA..AQIS	Center trunnion for heads	ISO MT5/MT6	●	●	1.16.93	1.100.57
21	∅ 32 ÷ 125	ST..AQIS	Support for center trunnion	ISO AT4	●	●		1.110.10
22	∅ 16 ÷ 125	ASV..	Magnetic reed switch T groove	-	●	●		1.113.1
		MK..	ATEX magnetic reed switch T groove	2014/34/EU	●	●		
23	∅ 16 ÷ 125	R..	Push-in fittings	-	●	●	4.2.1	
24	∅ 16 ÷ 125	V..C	Flow controls, for cylinders	-	●	●	4.94.1	

Key

● matching accessory; - not matching accessory

(1) Matching only with option M

Main features

16 ÷ 100

Bores Ø

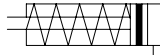

Single acting
Magnetic
With female thread

CIS

Type



16 ÷ 125

Bores Ø

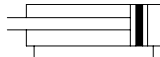

Double acting
Magnetic
With female thread

CI

Type



Technical data

Bore Ø mm	16	20	25	32	40	50	63	80	100	125	
Fluid	Filtered compressed air with or without lubrication. Lubrication, if started, must be continued.										
Pressure range	2 ÷ 10 bar										
Temperature range	-20°C ÷ +80°C (standard / V1)			-20°C ÷ +150°C (V)				-40°C ÷ +80°C (BT)			
Port	M5			1/8"				1/4"			
Grooves for reed switches	3			5				6		4	
Strokes	CIS	5 ÷ 50 mm								-	
	CI*	5 ÷ 250 mm			5 ÷ 400 mm						
Rod thread	CI-CIS	M4	M6	M8		M10		M12		M16	
	CIM-CISM	M6	M8x1,25	M10x1,25		M12x1,25		M16x1,5		M20x1,5	

* With option N the maximum stroke is 200 mm

Standard strokes

Stroke mm	CIS Bore Ø mm								
	16	20	25	32	40	50	63	80	100
5									
10									
15									
20									
25									
30									
40									
50									

Stroke mm	CI Bore Ø mm										
	16	20	25	32	40	50	63	80	100	125	
5	✓	✓	✓	✓	✓	✓	✓	✓			
10	✓	✓	✓	✓	✓	✓	✓	✓			
15	✓	✓	✓	✓	✓	✓	✓	✓			
20	✓	✓	✓	✓	✓	✓	✓	✓			
25	✓	✓	✓	✓	✓	✓	✓	✓			
30	✓	✓	✓	✓	✓	✓	✓	✓			
40	✓	✓	✓	✓	✓	✓	✓	✓			
50	✓	✓	✓	✓	✓	✓	✓	✓			
60		✓	✓	✓	✓	✓	✓	✓			
80				✓	✓	✓	✓	✓			
100											
160											
200											
250											
300											
350											
400											

Key
 Standard stroke

Theoretical thrust force Unit: N

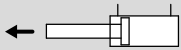

Ø Cylinder (mm)	Pressure (bar)
	6
16	-
20	188
25	294
32	482
40	754
50	1178
63	1869
80	3014
100	4710
125	-

Theoretical traction force Unit: N

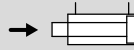

Ø Cylinder (mm)	Pressure (bar)
	6
16	-
20	141
25	247
32	414
40	633
50	989
63	1681
80	2720
100	4416
125	-

Theoretical spring force (for CIS type only) Unit: N

Ø Cylinder (mm)	Strokes (mm)															
	5		10		15		20		25		30		40		50	
	F1	F2	F1	F2	F1	F2	F1	F2	F1	F2	F1	F2	F1	F2	F1	F2
16	-	-	-	-	-	-	-	-	-	-	-	-	-	-	-	-
20	22	25	20	25	17	25	14	25	11	25	-	-	-	-	-	-
25	30	33	26	33	23	33	20	33	16	33	-	-	-	-	-	-
32	50	54	46	54	42	54	38	54	34	54	-	-	-	-	-	-
40	52	55	50	55	46	55	43	55	40	55	-	-	-	-	-	-
50	59	63	54	63	49	63	44	63	39	63	-	-	-	-	-	-
63	72	78	67	78	62	78	56	78	51	78	-	-	-	-	-	-
80	110	116	105	116	100	116	95	116	89	116	-	-	-	-	-	-
100	152	159	144	159	136	159	129	159	121	159	-	-	-	-	-	-

Standard dimensions

Type: **CIS-CI**
Ø 16 ÷ 25

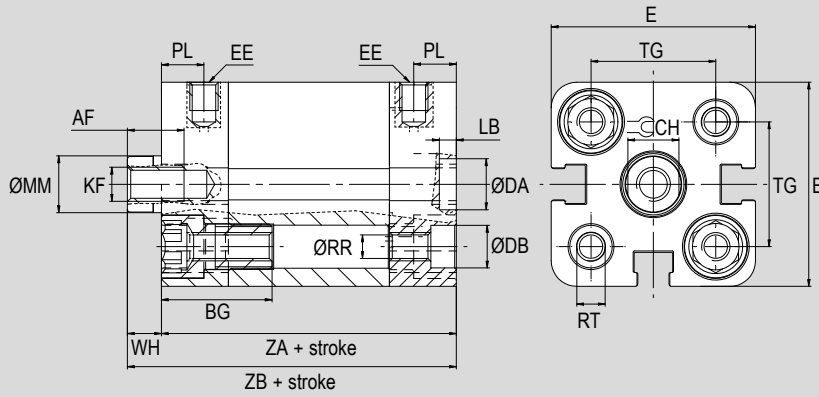

Type: **CIS-CI**
Ø 32 ÷ 50

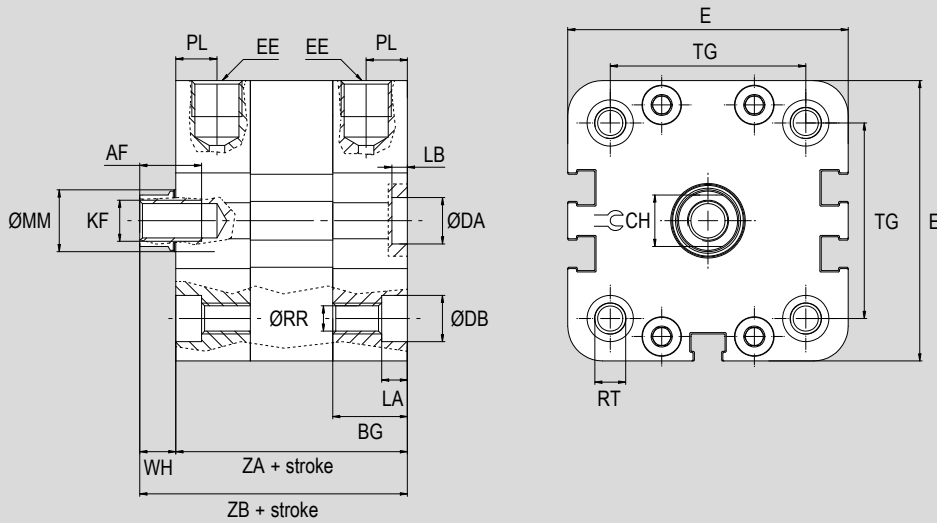

Ø (mm)	ØMM f7	AF	WH	ZA*	ZB*	KF	EE	BG	RR	TG	E	RT	LA	ØDB	PL	CH	ØDA h9	LB +0.1
16	8	10	4.5	35	39,5	M4	M5	11	3,2	18	29	M4	3,5	6	6,5	7	9	2,1
20	10	10	6	37	43	M6	M5	19,5	4,1	22	36	M5	4,5	7,5	7,5	9	9	3
25	10	10	6	39	45	M6	M5	19,5	4,1	26	40	M5	4,5	7,5	7,5	9	9	3
32	12	12	7	44	51	M8	G1/8"	14	5,1	32,5	49	M6	4,5	8	7,5	10	9	3
40	12	12	7	45	52	M8	G1/8"	14,5	5,1	38	54,5	M6	5	9	8	10	9	3
50	16	16	8	45	53	M10	G1/8"	14,5	6,6	46,5	65,5	M8	5	10,5	8	13	12	4

* CIS type Ø 20 ÷ 50, for strokes > 25 mm, add +20 mm to dimension;

Standard dimensions

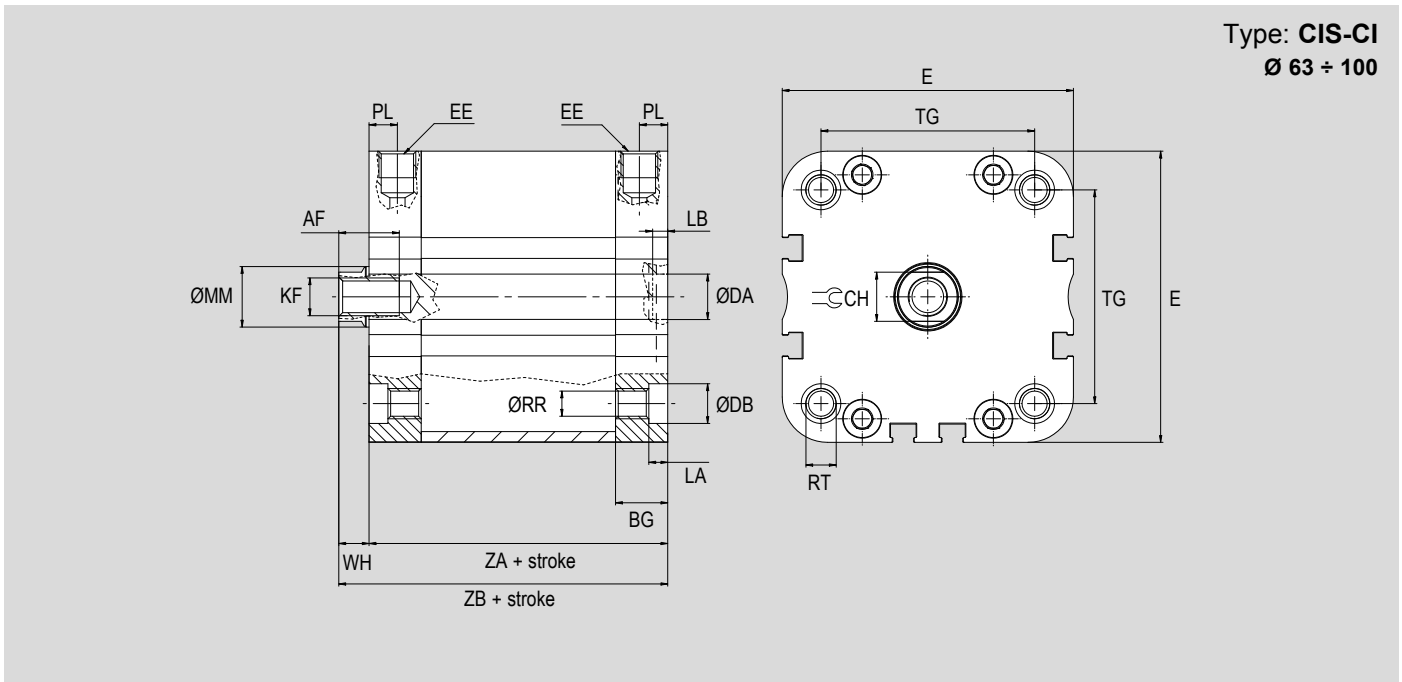

1 - CYLINDERS

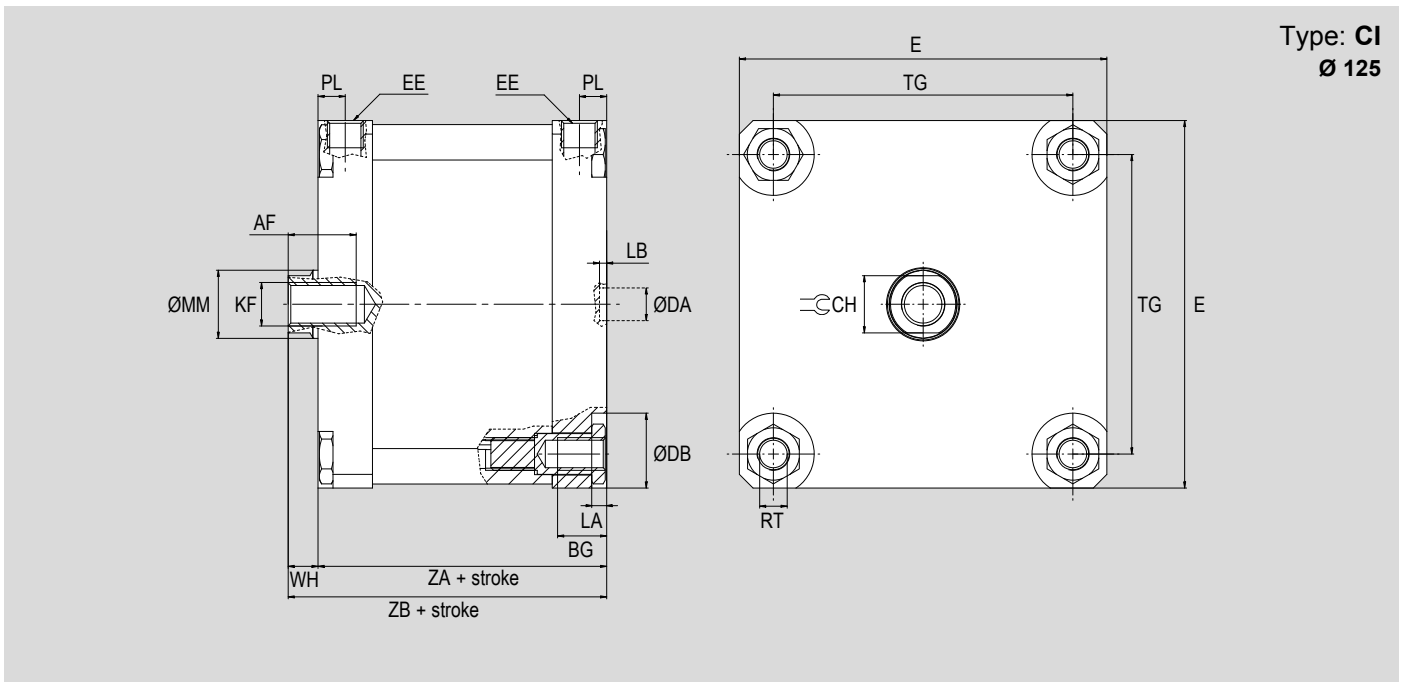

Ø (mm)	ØMM f7	AF	WH	ZA*	ZB*	KF	EE	BG	RR	TG	E	RT	LA	ØDB	PL	CH	ØDA h9	LB +0.1
63	16	16	8	49	57	M10	G1/8"	13,8	6,6	56,5	77	M8	5	10,5	7,5	13	12	4
80	20	20	10	54	64	M12	G1/8"	15	8,4	72	95,5	M10	3	13,5	8	17	12	4
100	25	20	10	67	77	M12	G1/8"	19,5	8,4	89	113,5	M10	3	14	10,5	21	12	4
125	25	25	11	81	92	M16	G1/4"	20	-	110	135	M12	-	-	10	21	12	2,6

* CIS type Ø 63 ÷ 100, for strokes > 25 mm, add +20 mm to dimension;

Dimensions with options

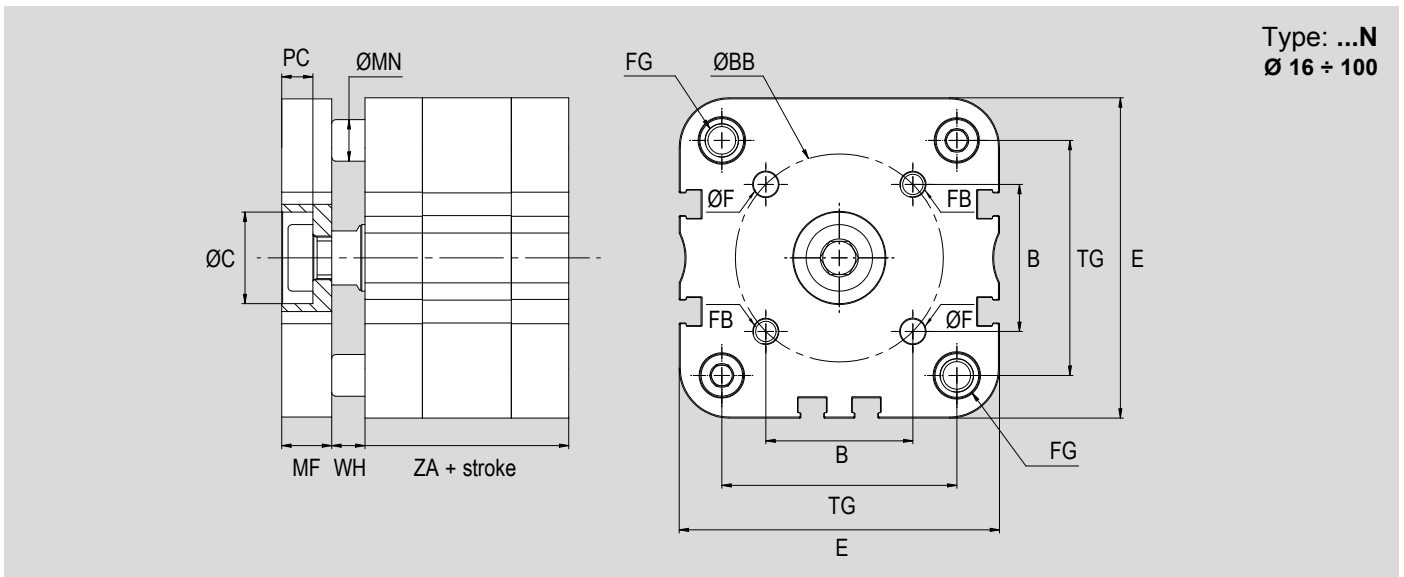
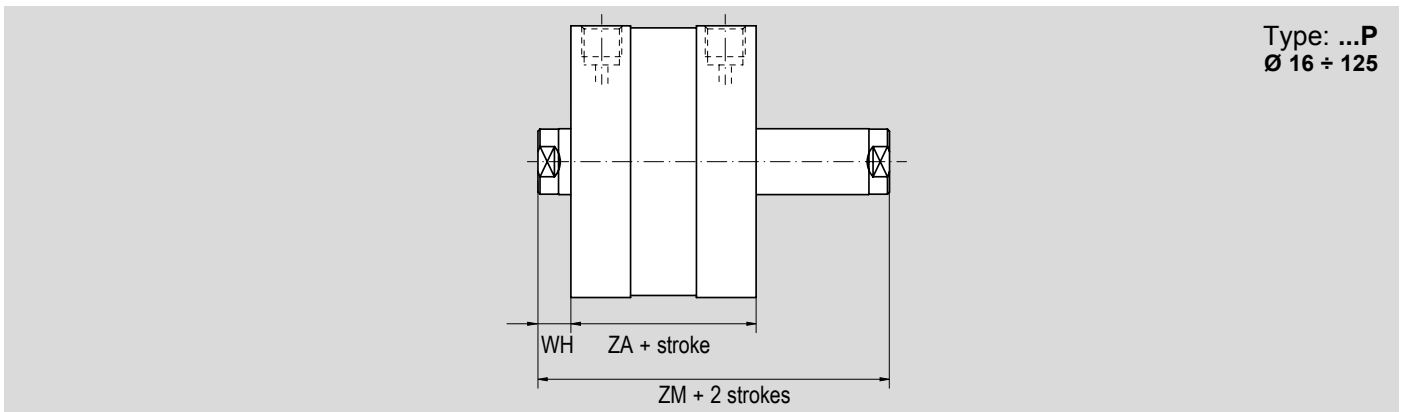
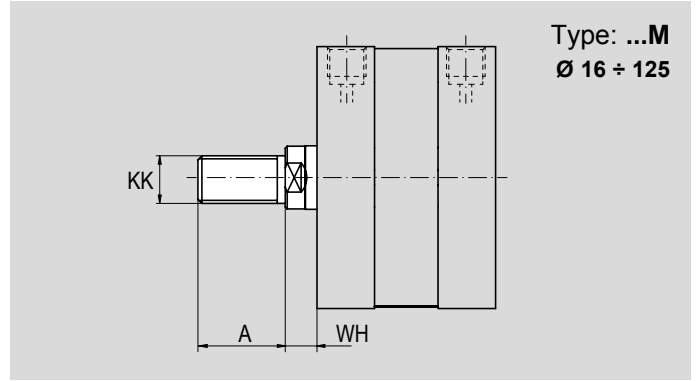
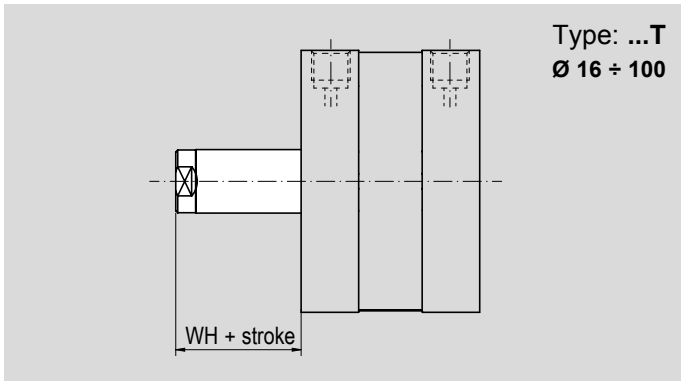

Ø (mm)	WH	MF +0.1	E	TG	B	FG	ØBB ±0.1	ØF +0.1	FB	ØC H9	PC	MN f7	ZA*	ZM*	KK	A
16	4,1	6	29	18	10	M4	14	3	M3	7,5	4,5	6	35	43,2	M6	12
20	6	8	36	22	12	M5	17	4	M4	11	5	6	37	49	M8x1,25	16
25	6	8	40	26	15,6	M5	22	5	M5	14	5	6	39	51	M8x1,25	16
32	7	10	49	32,5	19,8	M6	28	5	M5	17	6,5	6	44	58	M10x1,25	19
40	7	10	54,5	38	23,3	M6	33	5	M5	17	6,5	8	45	59	M10x1,25	19
50	8	12	65,5	46,5	29,7	M8	42	6	M6	22	7,5	10	45	61	M12x1,25	22
63	8	12	77	56,5	35,4	M8	50	6	M6	22	7,5	10	49	65	M12x1,25	22
80	10	14	95,5	72	46	M10	65	8	M8	28	9	14	54	74	M16x1,5	28
100	10	14	113,5	89	56,6	M10	80	10	M10	30	10	14	67	87	M16x1,5	28
125	11	-	-	-	-	-	-	-	-	-	-	-	81	103	M20x1,5	40

* CIS type Ø 20 ÷ 100, for strokes > 25 mm, add +20 mm to dimension;

Dimensions tandem versions

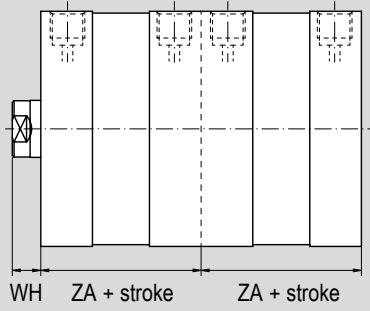

Type: ...TA1
Ø 25 - 40 - 63

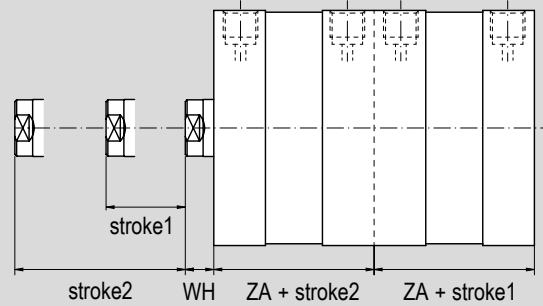

Type: ...TA2
Ø 25 - 40 - 63

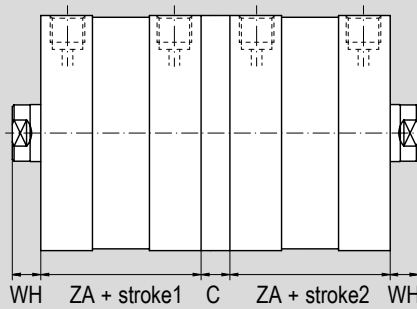

Type: ...TA3
Ø 20 ÷ 125

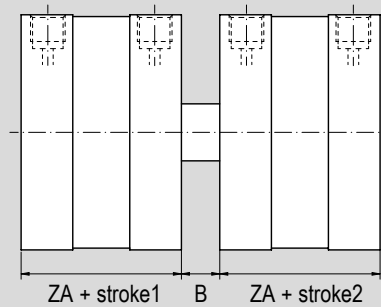

Type: ...TA4
Ø 20 ÷ 100

Ø mm	WH	ZA	B	C
20	6	37	9	13
25	6	39	11	13
32	7	44	12	15
40	7	45	13	15
50	8	45	15	15
63	8	49	15	15
80	10	54	16	17
100	10	67	20	19,5
125	11	81	-	19,5

Female clevis with clip FF..ISO

	For cylinder Ø mm	Code	Item	Compliance
	16	041002	FF06ISO/DIN	
	20-25	041003	FF08ISO/DIN	
	32-40	041004	FF10ISO	
	50-63	041005	FF12ISO	
	80-100	041006	FF16ISO	
	125	041007	FF20ISO	

Matching with option M only

Female clevis with pin and seeger FFP..ISO

	For cylinder Ø mm	Code	Item	Compliance
	16	-	FFP06ISO/DIN	
	20-25	-	FFP08ISO/DIN	
	32-40	041051	FFP10ISO	
	50-63	041040	FFP12ISO	
	80-100	041013	FFP16ISO	
	125	041017	FFP20ISO	

Matching with option M only

Female clevis (body only) FFN..ISO

	For cylinder Ø mm	Code	Item	Compliance
	16	041011	FFN06ISO/DIN	
	20-25	041018	FFN08ISO/DIN	
	32-40	041014	FFN10ISO	
	50-63	041016	FFN12ISO	
	80-100	041012	FFN16ISO	
	125	041015	FFN20ISO	

Matching with option M only

Bearing heads (DIN 648K) with female thread RF..SE

	For cylinder Ø mm	Code	Item	Compliance
	16	041552	RF6SE	
	20-25	041553	RF8SE	
	32-40	041554	RF10SE	
	50-63	041555	RF12SE	
	80-100	041557	RF16SE	
	125	041559	RF20SE	

Matching with option M only

Bearing heads (DIN 648K) with male thread RM..SE

	For cylinder Ø mm	Code	Item	Compliance
	16	041500	RM4SE	
	20-25	041502	RM6SE	
	32-40	041503	RM8SE	
	50-63	041550	RM10SE/M10x1,5	
	80-100	041514	RM12SE/M12	
	125	041517	RM16SE/M16	

Self-aligning articulated coupling GB..

	For cylinder Ø mm	Code	Item	Compliance
	16	041702	GB010	-
	20-25	041703	GB020	
	32-40	041704	GB040	
	50-63	041706	GB060	
	80-100	041708	GB100	
	125	041709	GB120	

Matching with option M only

Axial articulated coupling RBL..

	For cylinder Ø mm	Code	Item	Compliance
	32-40	041604	RBL10	-
	50-63	041605	RBL12	
	80-100	041607	RBL16	
	125	041609	RBL20	

Matching with option M only

Angular articulated coupling RBL..

	For cylinder Ø mm	Code	Item	Compliance
	32-40	041654	RBL10	-
	50-63	041655	RBL12	
	80-100	041657	RBL16	
	125	041659	RBL20	

Matching with option M only

Self-aligning coupling GC..

	For cylinder Ø mm	Code	Item	Compliance
	32-40	041722	GCM10x1,25	-
	50-63	041723	GCM12x1,25	
	80-100	041724	GCM16x1,5	
	125	041725	GCM20x1,5	

Matching with option M only

Rear clevis in aluminium with screws and pin CF..ALIS+VP

	For cylinder Ø mm	Code	Item	Compliance
	32	042050	CF032ALIS+VP	
	40	042051	CF040ALIS+VP	
	50	042052	CF050ALIS+VP	
	63	042053	CF063ALIS+VP	
	80	042054	CF080ALIS+VP	
	100	042055	CF100ALIS+VP	
	125	042056	CF125ALIS+VP	

Narrow rear clevis in aluminium with screws and pin CFS..ALIS+VP

	For cylinder Ø mm	Code	Item	Compliance
	32	042110	CFS032ALIS+VP	
	40	042111	CFS040ALIS+VP	
	50	042112	CFS050ALIS+VP	
	63	042113	CFS063ALIS+VP	
	80	042114	CFS080ALIS+VP	
	100	042115	CFS100ALIS+VP	
	125	042116	CFS125ALIS+VP	

Rear clevis in aluminium* with screws CF..ALIS+V

	For cylinder Ø mm	Code	Item	Compliance
	32	040441	CF032ALIS+V	
	40	040442	CF040ALIS+V	
	50	040443	CF050ALIS+V	
	63	040444	CF063ALIS+V	
	80	040445	CF080ALIS+V	
	100	040446	CF100ALIS+V	
	125	040447	CF125ALIS+V	

Narrow rear clevis in aluminium* with screws CFS..ALIS+V

	For cylinder Ø mm	Code	Item	Compliance
	32	040451	CFS032ALIS+V	
	40	040452	CFS040ALIS+V	
	50	040453	CFS050ALIS+V	
	63	040454	CFS063ALIS+V	
	80	040455	CFS080ALIS+V	
	100	040456	CFS100ALIS+V	
	125	040457	CFS125ALIS+V	

*Available also in steel (item CF..AQIS+V) in Ø 32 ÷ 125, see page 1.100.50

*Available also in steel (item CFS..AQIS+V) in Ø 32 ÷ 125, see page 1.100.50

Rear eye in aluminium* CM..ALUN

	For cylinder Ø mm	Code	Item	Compliance
	16	040701	CM012/016ALUN	
	20	040702	CM020ALUN	
	25	040703	CM025ALUN	

*Available also in steel (item CM..AQUN) in Ø 20 ÷ 25, see page 1.100.51
Screws to be ordered separately, see page 1.101.40

Rear eye in aluminium* with screws CM..ALIS+V

	For cylinder Ø mm	Code	Item	Compliance
	32	042061	CM032ALIS+V	
	40	042062	CM040ALIS+V	
	50	042063	CM050ALIS+V	
	63	042064	CM063ALIS+V	
	80	042065	CM080ALIS+V	
	100	042066	CM100ALIS+V	
	125	042067	CM125ALIS+V	

*Available also in steel (item CM..AQIS+V) in Ø 32 ÷ 125, see page 1.100.51

Narrow rear eye with bearing (DIN 648K) in aluminium* with screws CMS..ALIS+V

	For cylinder Ø mm	Code	Item	Compliance
	32	042101	CMS032ALIS+V	
	40	042102	CMS040ALIS+V	
	50	042103	CMS050ALIS+V	
	63	042104	CMS063ALIS+V	
	80	042105	CMS080ALIS+V	
	100	042106	CMS100ALIS+V	
	125	042107	CMS125ALIS+V	

Available also in steel (item CMS..AQIS+V) in Ø 32 ÷ 125, see page 1.100.52

Rod nut D..

	For cylinder Ø mm	Code	Item	Compliance
	16	041450	D6x1	
	20-25	041451	D8x1,25	
	32-40	041452	D10x1,25	
	50-63	041454	D12x1,25	
	80-100	041455	D16x1,5	
	25	041456	D20x1,5	

Matching with option M only

Pin with seeger* in steel SEC..AQIS

	For cylinder Ø mm	Code	Item	Compliance
	32	040261	SEC032AQIS	
	40	040262	SEC040AQIS	
	50	040263	SEC050AQIS	
	63	040264	SEC063AQIS	
	80	040265	SEC080AQIS	
	100	040266	SEC100AQIS	
	125	040267	SEC125AQIS	

*Supplied with 2 seeger

Anti-rotating pin with seeger* in steel SEC..ARAQIS

	For cylinder Ø mm	Code	Item	Compliance
	32	040571	SEC032ARAQIS	
	40	040572	SEC040ARAQIS	
	50	040573	SEC050ARAQIS	
	63	040574	SEC063ARAQIS	
	80	040575	SEC080ARAQIS	
	100	040576	SEC100ARAQIS	
	125	040577	SEC125ARAQIS	

*Supplied with 1 seeger

Flange in aluminium FL..ALUN

	For cylinder Ø mm	Code	Item	Compliance
	12-16	040721	FL012/016ALUN	
	20	040722	FL020ALUN	
	25	040723	FL025ALUN	

Screws to be ordered separately, see page 1.101.40

Flange in aluminium with screws FLV..ALIS+V

	For cylinder Ø mm	Code	Item	Compliance
	32	042150	FLV032ALIS+V	
	40	042151	FLV040ALIS+V	
	50	042152	FLV050ALIS+V	
	63	042153	FLV063ALIS+V	
	80	042154	FLV080ALIS+V	
	100	042155	FLV100ALIS+V	
	125	042156	FLV125ALIS+V	

Flange in steel FL..AQUN

	For cylinder Ø mm	Code	Item	Compliance
	12-16	040751	FL012/016AQUN	
	20	040752	FL020AQUN	
	25	040753	FL025AQUN	

Screws to be ordered separately, see page 1.101.40

Flange in steel with screws FLV..AQIS+V

	For cylinder Ø mm	Code	Item	Compliance
	32	042119	FLV032AQIS+V	
	40	042120	FLV040AQIS+V	
	50	042121	FLV050AQIS+V	
	63	042122	FLV063AQIS+V	
	80	042123	FLV080AQIS+V	
	100	042124	FLV100AQIS+V	
	125	042125	FLV125AQIS+V	

Low foot* in steel PB..AQUN

	For cylinder Ø mm	Code	Item	Compliance
	16	040761	PB012/016AQUN	
	20	040762	PB20AQUN	
	25	040763	PB25AQUN	

*Supplied individually

Screws to be ordered separately, see page 1.101.40

Low foot* in steel with screws PB..AQIS+V

	For cylinder Ø mm	Code	Item	Compliance
	32	042129	PB032AQIS+V	
	40	042130	PB040AQIS+V	
	50	042131	PB050AQIS+V	
	63	042132	PB063AQIS+V	
	80	042133	PB080AQIS+V	
	100	042134	PB100AQIS+V	
	125	042135	PB125AQIS+V	

*Supplied individually

Center trunnion for heads in steel with screws CTA..AQIS+V

	For cylinder Ø mm	Code	Item	Compliance
	32	040591	CTA032AQIS+V	 MT5/MT6
	40	040592	CTA040AQIS+V	
	50	040593	CTA050AQIS+V	
	63	040594	CTA063AQIS+V	
	80	040595	CTA080AQIS+V	
	100	040596	CTA100AQIS+V	
	125	040598	CTA125AQIS+V	

Support ST..AQIS to be ordered separately, see next

Support for center trunnion* in steel ST..AQIS

	For cylinder Ø mm	Code	Item	Compliance
	32	040681	ST032AQIS	 AT4
	40-50	040682	ST040/050AQIS	
	63-80	040684	ST063/080AQIS	
	100-125	040686	ST100/125AQIS	

*Supplied individually

Rear 90° hinge in aluminium* with screws ASV..ALIS+V

	For cylinder Ø mm	Code	Item	Compliance
	32	042081	ASV032ALIS+V	 AB7 RP 107P
	40	042082	ASV040ALIS+V	
	50	042083	ASV050ALIS+V	
	63	042084	ASV063ALIS+V	
	80	042085	ASV080ALIS+V	
	100	042086	ASV100ALIS+V	
	125	042087	ASV125ALIS+V	

*Available also in steel: item CF..+P for Ø 16 ÷ 25 and item ASV..AQIS ifor Ø 32 ÷ 125, see page 1.100.53

Rear 90° hinge in aluminium AS..ALIS

	For cylinder Ø mm	Code	Item	Compliance
	32	040361	AS032ALIS	 6431
	40	040362	AS040ALIS	
	50	040363	AS050ALIS	
	63	040364	AS063ALIS	
	80	040365	AS080ALIS	
	100	040366	AS100ALIS	
	125	040367	AS125ALIS	

Rear 90° hinge with bearing (DIN 648K) in steel ASS..AQIS

	For cylinder Ø mm	Code	Item	Compliance
	32	040551	ASS032AQIS	 CS7
	40	040552	ASS040AQIS	
	50	040553	ASS050AQIS	
	63	040554	ASS063AQIS	
	80	040555	ASS080AQIS	
	100	040556	ASS100AQIS	
	125	040557	ASS125AQIS	

Magnetic reed switch T groove ASV..

	For cylinder Ø mm	Code	Item	Cylinder matching
	16 ÷ 125	070946	ASV1C525	 CIS CI
		071863	ASV1C550	
		071864	ASV1C51K	
		071189	ASV1C5M8	
		073639	ASV4D225	
		070246	ASV4D2M8	
		070247	ASV7N2M8	
		070372	ASV7M2M8	
		072918	ASV1H525	

ATEX magnetic reed switch T groove MK..

	For cylinder Ø mm	Code	Item	Compliance	Cylinder matching
	16 ÷ 125	071120	MK500A	 3D	 CIS CI
		071108	MK502A	 II1G	